

101 06 1013--,-,---
Mono 060 Surface IP Type 3

LED Power Supply 180mA Included

8W 240V-AC
Class III
IP55

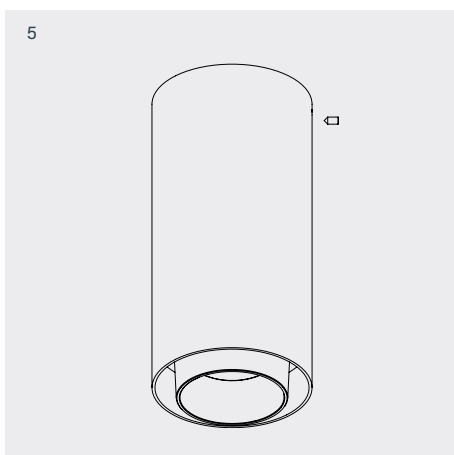
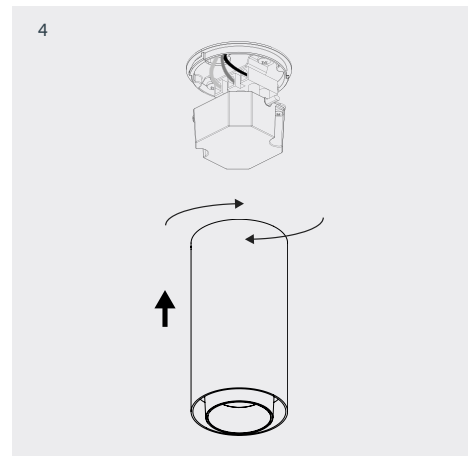
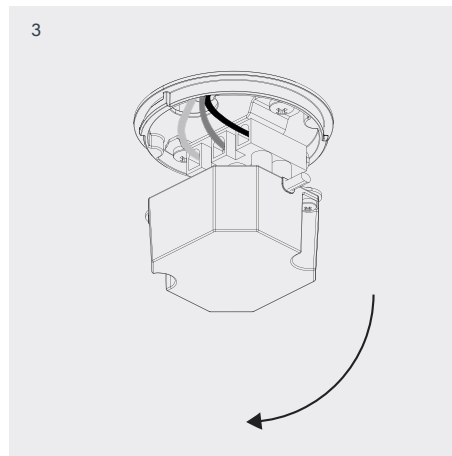
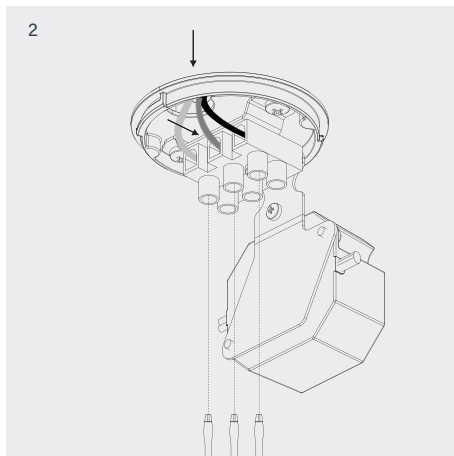
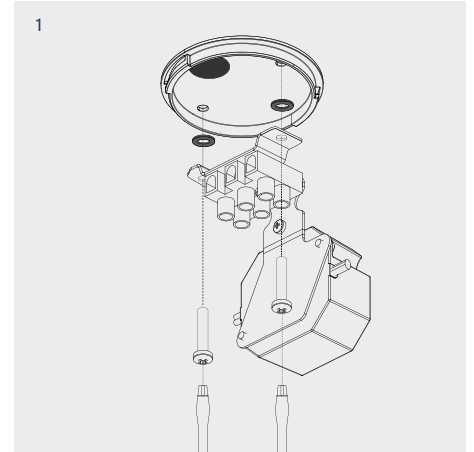
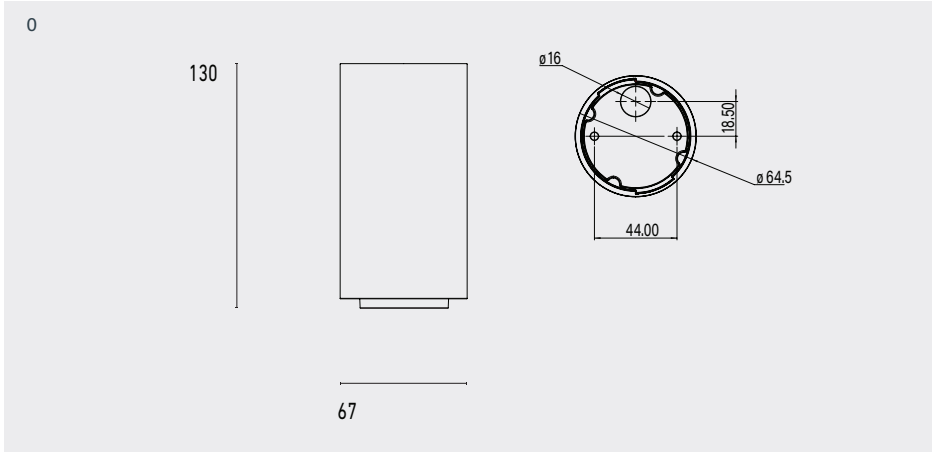

- 1 Screw base onto ceiling using supplied gaskets between screw and inside of ceiling base.
- 2 Feed cables through the lid's power entry hole and secure them into the terminal block.
- 3 Fold driver mount bracket to 90 degrees.
- 4 Slide Mono 060 fixture over the ceiling base and rotate to lock into position.
- 5 Fix fixture to ceiling base with grub screw provided.